

NUMBER GS-12-006	TYPE PRODUCT SPECIFICATION		
TITLE Conan™ Micro miniature Connector System		PAGE 1 of 17	REVISION U
		AUTHORIZED BY Bob Gu	DATE 08 Jun 21
CLASSIFICATION UNRESTRICTED			

1.0 OBJECTIVE

This specification defines the performance, test, quality, and reliability requirements of the Conan™ Micro miniature Connector System as well as Lead Free product that meets the requirement of the European Union Directives of Restriction for Hazardous Substances (Directive 2002/95/EC).

2.0 SCOPE

This specification is applicable to the termination characteristics of the Conan™ connector system, which provides for parallel interconnection of printed wiring boards in low power applications.

3.0 GENERAL

<u>PARAGRAPH</u>	<u>TITLE</u>
1.0	Objective
2.0	Scope
3.0	General
4.0	Applicable Documents
5.0	Requirements
5.1	Qualification
5.2	Material
5.3	Finish
5.4	Design and Construction
6.0	Electrical Characteristics
7.0	Mechanical Characteristics
8.0	Environmental Conditions
9.0	Quality Assurance Provisions
9.1	Equipment Calibration
9.2	Inspection Conditions
9.3	Sample Quantities and Description
9.4	Qualification Testing
9.5	Requalification Testing

4.0 APPLICABLE DOCUMENTS

In the event of a conflict between the requirements outlined in this specification and the product drawing, the product drawing shall take precedence. In the event of a conflict between the requirements outlined in this specification and the referenced documents, this specification shall take precedence.

NUMBER GS-12-006	TYPE PRODUCT SPECIFICATION		
TITLE Conan™ Micro miniature Connector System		PAGE 2 of 17	REVISION U
		AUTHORIZED BY Bob Gu	DATE 28 Jan 21
		CLASSIFICATION UNRESTRICTED	

4.1 SPECIFICATIONS

4.1.1 Engineering Drawings 91900, 10084781 & 10086244 & 10137985

4.2 MILITARY STANDARDS

4.2.1 MIL-STD-202F: Test Methods for Electronic Component Parts
4.2.2 EIA-364: Test Methods for Electrical Connectors
4.2.3 MIL-C-45662: Equipment Calibration

4.3 FEDERAL SPECIFICATIONS

4.3.1 QQ-N-290: Nickel Plating (Electrodeposited)
4.3.2 QQ-N-533: Beryllium Copper Alloy Strip
4.3.3 QQ-B-750: Phosphor Bronze Alloy Strip
4.3.4 QQ-B-613: Cartridge Brass Alloy Strip
4.3.5 QQ-S-571: Solder

4.4 OTHER STANDARDS AND SPECIFICATIONS

4.4.1 UL-94: Flammability
4.4.2 ASTM B-19: Brass
4.4.3 ASTM B-36: Brass
4.4.3 ASTM B-194: Beryllium Copper
4.4.4 ASTM B-103: Phosphor Bronze
4.4.5 ISO 9000

4.5 FCI SPECIFICATIONS

4.5.1 BUS-03-114: Capacitance Measurement
4.5.2 BUS-03-404: Normal Force Measurement
4.5.3 GS-19-037: Solderability
4.5.4 GS-19-036: Porosity
4.5.5 GS-19-039: Plating Adhesion

4.6 FCI LAB REPORTS - SUPPORTING DATA

4.6.1 EL-93-03-062: Qualification Testing
4.6.2 EL-93-03-062B: Qualification Testing
4.6.3 EL-92-08-051: Qualification Testing
4.6.4 EL-94-01-031: Qualification Testing
4.6.5 EL-2004-09-024: Qualification Testing
4.6.6 ZA5-2625 Lead-free plating investigation (DOE pure tin)

NUMBER GS-12-006	TYPE PRODUCT SPECIFICATION		
TITLE Conan™ Micro miniature Connector System		PAGE 3 of 17	REVISION U
		AUTHORIZED BY Bob Gu	DATE 28 Jan 21
		CLASSIFICATION UNRESTRICTED	

5.0 REQUIREMENTS

5.1 QUALIFICATION

Connectors furnished under this specification shall be products that are capable of meeting the qualification test requirements specified herein.

5.2 MATERIAL

The material for each part shall be as specified herein, or equivalent. Substitute material shall meet the performance requirements of this specification.

- 5.2.1 Receptacle Terminal. The base material shall be beryllium copper strip C17200, SHM (TMO5).
- 5.2.2 Header Terminal. The base material shall be 3/4 hard phosphor bronze strip C51000.
- 5.2.3 Header and Receptacle Insulator Housing. The insulators shall be molded of 30% glass filled liquid crystal polymer that is rated 94V-0 or better in accordance with UL-94.
- 5.2.4 Hold-Down. The base material shall be full hard, brass strip C26000. See Section 5.3.2 for plating requirements.

5.3 FINISH

- 5.3.1 The header and receptacle terminals shall be plated in the contact area with 15 microinches min. GXT™, 30 microinches min. GXT™ or 50 microinches min. Gold (dependent on finish specified by part number) over 50 microinches Nickel or Copper. The terminal soldertail shall be plated with 200 microinhces min. tin lead, 100 microinches min. tin lead or pure tin over 50 microinches min. Nickel or Copper . The terminal areas outside of the contact area and soldertail areas shall be plated with 50 microinches min. Nickel or Copper.
- 5.3.2 The hold-down shall be plated with 100 microinches min. tin lead or pure tin over 50 microinches min. Nickel or Copper.

5.4 DESIGN AND CONSTRUCTION

The connector shall be a multi-piece assembly having two rows of contacts with surface mount soldertail terminations and solderable surface mount retention devices for installation on surface mount printed wiring boards or flexible circuits.

- 5.4.1 Mating. The connector shall be capable of mating and unmating manually without the use of special tools.
- 5.4.2 Workmanship. Connectors shall be uniform in quality and shall be free from burrs, scratches, cracks, voids, chips, blisters, pin holes, sharp edges, and other defects that will adversely affect life or serviceability. Open knit lines, which may appear as a crack, may be present in the housing but do not adversely affect the performance of the connector as per the requirements outlined in this specification.

NUMBER GS-12-006	TYPE PRODUCT SPECIFICATION		
TITLE Conan™ Micro miniature Connector System		PAGE 4 of 17	REVISION U
		AUTHORIZED BY Bob Gu	DATE 28 Jan 21
		CLASSIFICATION UNRESTRICTED	

5.5 RATING

Voltage Rating	100V AC
Current Rating	1.0A Max.
Temperature Rating	-55°C ~ 125°C

6.0 ELECTRICAL CHARACTERISTICS

6.1 CURRENT RATING

The maximum current rating based upon a 30 degree C temperature rise over ambient is 1.0 amp DC per contact for a 69 position connector with all contacts carrying current. The maximum current carrying capacity for an individual contact is 2.0 amps D.C.

6.2 LOW LEVEL CONTACT RESISTANCE

The low level contact resistance of the 4.15mm, 4.5mm, 5mm and 5.5mm mated height connectors shall not exceed 20 milliohms initially and 30 milliohms after environmental exposure when measured in accordance with EIA-364 TP45. The low level contact resistance of the 6mm, 7mm and 7.5mm mated height connectors shall not exceed 25 milliohms initially and 35 milliohms after environmental exposure when measured in accordance with EIA-364 TP45. The following details shall apply:

- A. Method of connection: Attach current and voltage leads as shown in Figure 1.0. The resistance shall be measured from the solder tail of the header to the solder tail of the receptacle.
- B. Test Voltage: 20 millivolts DC max open circuit.
- C. Test Current: Not to exceed 100 milliamperes.

6.3 INSULATION RESISTANCE

The insulation resistance of the mated connectors shall not be less than 1 gigaohm after environmental exposure when measured in accordance with MIL-STD-202F, Method 302. The following details shall apply:

- A. Test voltage: 500 volts DC
- B. Preparation: The connectors shall be mated but not soldered to a P.C. board.
- C. Measurement points: The insulation resistance shall be measured between a minimum of 10 adjacent and 10 opposing contacts per connector.

6.4 DIELECTRIC WITHSTANDING VOLTAGE

There shall be no evidence of arc-over, insulation breakdown or leakage current in excess of 1 milliampere when the unmated connector is tested in accordance with MIL-STD-202F, Method 301. The following details shall apply:

NUMBER GS-12-006	TYPE PRODUCT SPECIFICATION		
TITLE Conan™ Micro miniature Connector System		PAGE 5 of 17	REVISION U
		AUTHORIZED BY Bob Gu	DATE 28 Jan 21

- A. Test voltage: 500 volts rms at 60 Hz.
- B. Test duration: 60 seconds
- C. Preparation: The connectors shall be mounted but not soldered to a P.C. board.
- D. Measurement points: The dielectric withstanding voltage shall be applied across a minimum of 10 adjacent and 10 opposing contacts.

6.5 CAPACITANCE

The capacitance between adjacent and opposing contacts in a mated connector shall not exceed 2.0 picofarads when tested in accordance with Du Pont specification BUS-03-114. The following details shall apply:

- A. Test frequency: 100 khz
- B. Preparation: The connectors shall be mated but not soldered to a P.C. board.
- C. Measurement points: The capacitance shall be measured across a minimum of 10 adjacent and 10 opposing contacts.

7.0 MECHANICAL CHARACTERISTICS

7.1 CONTACT RETENTION

Individual contacts in the unterminated header and receptacle portions of the connector shall withstand a load normal to the soldertail of 0.25 min. pounds. The force shall be measured on a minimum of 10 contacts per unmated header and receptacle connector. The crosshead speed shall be no greater than 0.2 inches per minute.

7.2 MATING FORCE

The force to mate header and receptacle connectors that are mounted on a P.C. board shall not exceed 125 grams per contact. The crosshead speed shall be no greater than 1.0 inches per minute.

7.3 UNMATING FORCE

The force to unmate header and receptacle connectors that are mounted on a P.C. board shall be no less than 45 grams per contact. The crosshead speed shall be no greater than 1.0 inch per minute.

7.4 NORMAL FORCE

NUMBER GS-12-006	TYPE PRODUCT SPECIFICATION		
TITLE Conan™ Micro miniature Connector System		PAGE 6 of 17	REVISION U
		AUTHORIZED BY Bob Gu	DATE 28 Jan 21
		CLASSIFICATION UNRESTRICTED	

The contact normal force shall not be less than 75 grams when tested in accordance with BUS-03-404 Section 3.2 (probe method). Refer to Figure 2.0. The following process shall be used:

- 7.4.1 Solder the receptacle and header connectors to a printed circuit board.
- 7.4.2 Select the receptacle terminal positions to be measured.
- 7.4.3 Measure the maximum terminal gap between the selected positions and the opposite row of terminals in the receptacle connector.
- 7.4.4 Measure the minimum width across the selected positions and the opposite row of terminals of the header connector.
- 7.4.5 Using an "L" shaped probe, Lab Fixture Number MF149, Figure 2, deflect the contact positions on the instron tester.

- 7.4.6 The minimum beam deflection occurs on the long row of terminals. Calculate the minimum beam deflection as follows:

V = Minimum width across the header terminals.
W = Maximum gap between receptacle terminals.
Z = Deflection of terminals in the long row.
A = Number of terminals in the short row.
B = Number of terminals in the long row.

$$\text{Minimum deflection (Z)} = \frac{A*(V-W)}{(A+B)}$$

- 7.4.7 Starting at the bottom of the force-deflection curve where the terminal begins to deflect, move up the curve a distance equal to the minimum deflection, Z, to find the minimum normal force. Measure a minimum of 5 contacts per connector.

7.5 BOARD RETENTION

The force to remove the header and receptacle connectors from a P.C. board shall be no less than 10 lbs. when both the hold-downs and the terminal leads are soldered in place. The crosshead speed shall be no greater than 0.2 inches per minute.

NUMBER GS-12-006	TYPE PRODUCT SPECIFICATION		
TITLE Conan™ Micro miniature Connector System		PAGE 7 of 17	REVISION U
		AUTHORIZED BY Bob Gu	DATE 28 Jan 21
		CLASSIFICATION UNRESTRICTED	

8.0 ENVIRONMENTAL CONDITIONS

After exposure to the following environmental conditions in accordance with the specified test procedures and/or details, the product shall show no physical damage and shall meet the electrical and mechanical requirements per paragraphs 6.0 and 7.0 as specified in the Table 1.0 test sequences. Unless specified otherwise, the assemblies shall be mated during exposure.

8.1 HUMIDITY, STEADY STATE - MIL-STD-202F, METHOD 103B

- A. Relative humidity: 90% +/- 5%
- B. Temperature: 40 +/- 3 Deg. C
- C. Test Duration: 96 hours
- D. Samples: Groups 1 and 2 - unmated during exposure.

8.2 THERMAL SHOCK - MIL-STD-202F, METHOD 107G

- A. Test condition: A - (25, 1 hour cycles).
- B. Temperature range: -55 +/- 5 to +130 +/- 0 Deg. C.
- C. Time at each temperature: 30 minutes
- D. Transfer time: 5 minutes max.
- E. Samples: Groups 1 and 2 - unmated during exposure.

8.3 ENVIRONMENTAL SEQUENCE

Phase 1 - Thermal shock, MIL-STD-202F, Method 107G.

- A. Test duration - 36, 1-hour cycles
- B. Temperature range - between -20 and +80 deg. C.
- C. Time at temperature - 30 minutes
- D. Transfer time - 5 minutes, maximum

Phase 2 - Humidity, MIL-STD-202F, Method 103B.

- A. Test duration - 10 days
- B. Relative humidity - 95%
- C. Temperature - 40 +/- 3 deg. C.

8.3.1 - High Tem Life MIL-STD-202F, Method 108A

- A. Test Duration - 21 days
- B. Temperature - 105 deg. C.

NUMBER GS-12-006	TYPE PRODUCT SPECIFICATION		
TITLE Conan™ Micro miniature Connector System		PAGE 8 of 17	REVISION U
		AUTHORIZED BY Bob Gu	DATE 28 Jan 21
		CLASSIFICATION UNRESTRICTED	

8.4 SHOCK - MIL-STD-202F, METHOD 213B

- A. Condition - A, (50G, 11 ms half-sine) contacts shall show no evidence of discontinuity greater than one microsecond. The following details shall apply:
- B. Shocks: 3 shocks in both directions along each of 3 orthogonal axes (18 total).
- C. Mounting: See Figure 3.0.
- D. No discontinuities greater than 1.0 microseconds.

8.5 VIBRATION - MIL-STD-202F, METHOD 204D

- A. Condition: B
- B. Vibration Amplitude: +/-15G or .06" da.
- C. Frequency range: 10 to 2000 hz.
- D. Sweep time and duration: 20 minutes per sweep, 4 hours along each of 3 orthogonal axes (12 hours total).
- E. Mounting: See Figure 3.0.

8.6 INDUSTRIAL MIXED FLOWING GAS - BATTELLE PROCEDURE

- A. Class: IIa
- B. Duration: 20 days, mated

8.7 SOLDERABILITY - MIL-STD-202F METHOD 208F

- A. Contact tails shall be solderable over a minimum of .035 from the tip.
- B. Steam aging: Suspended 2 inches above boiling, distilled water for 4 hours.
- C. Acceptable coverage: 95% minimum.
- D. Solder: 60/40 tin-lead in accordance with QQ-S-571, Type S.
- E. Flux: Type RMA.
- F. Flux immersion time: 10 seconds.

NUMBER GS-12-006	TYPE PRODUCT SPECIFICATION		
TITLE Conan™ Micro miniature Connector System		PAGE 9 of 17	REVISION U
		AUTHORIZED BY Bob Gu	DATE 28 Jan 21
		CLASSIFICATION UNRESTRICTED	

G. Solder dwell time: Terminal held immediately above solder for 10 seconds and then immersed for 5 +/- 0.5 seconds. The solder tails shall be bent normal to the base of the connector to prevent the insulator from touching the solder bath.

H. Solder temperature: 245 +/- 5 deg. C.

I. Samples: Group 7 - unsoldered and unmated.

8.8 RESISTANCE TO IR SOLDERING HEAT

A. Temperature: 260°C ± 5° C (peak temperature)

B. Duration: 30 seconds.

8.9 DURABILITY - STANDARD LABORATORY PROCEDURES

A. Number of cycles: 30 cycles for 15u" GXT Contact Finish
 200 cycles for 30u" GXT Contact Finish

B. Crosshead speed: 1 inch/minute max.

9.0 QUALITY ASSURANCE PROVISIONS

9.1 EQUIPMENT CALIBRATION

All test equipment and inspection facilities used in the performance of any test shall be maintained in a calibration system in accordance with MIL-C-45662 and ISO 9000.

9.2 INSPECTION CONDITIONS

Unless otherwise specified herein, all inspections shall be performed under the following ambient conditions:

A. Temperature: 25 +/- 5 deg. C.

B. Relative humidity: 30 to 60%

C. Barometric pressure: Local ambient.

NUMBER GS-12-006	TYPE PRODUCT SPECIFICATION		
TITLE Conan™ Micro miniature Connector System		PAGE 10 of 17	REVISION U
		AUTHORIZED BY Bob Gu	DATE 28 Jan 21
		CLASSIFICATION UNRESTRICTED	

9.3 SAMPLE QUANTITIES

Sample quantities for the respective test groups are as follows:

Test Group	Size (number of positions)	Connector Height	Quantity
1	69	4.15	3
2	69	4.15	3
3 3A	21 & 69 21 & 69	4.15 & 7.0 4.15 & 7.0	3 ea. 3 ea.
4	21	7.0	3
5 5A	69 69	7.0 7.0	3 3
6	69	4.15 & 7.0	3 ea.
7	69	7.0	3
8	9 & 21 & 69	7.0	3 ea.
9	69	N/A	3
10	21 & 69	4.15 & 7.0	3 ea.
11	69	7.0	1
11A	69	7.0	1
11B	69	7.0	1
12	69	4.15 & 7.0	1 ea.
13 13A	69 69	4.15 4.15	3 3

NUMBER GS-12-006	TYPE PRODUCT SPECIFICATION		
TITLE Conan™ Micro miniature Connector System		PAGE 11 of 17	REVISION U
		AUTHORIZED BY Bob Gu	DATE 28 Jan 21
		CLASSIFICATION UNRESTRICTED	

9.4 QUALIFICATION TESTING

Qualification testing shall be performed on sample units produced with equipment and procedures normally used in production. The test sequence shall be as shown in Table 1.

9.5 REQUALIFICATION TESTING

If either of the following conditions occurs, the responsible product engineer shall initiate requalification testing consisting of all applicable parts of the qualification test matrix, Table 1.

- A. A significant design change is made to the existing product. A significant change shall include, but is not limited to, changes in the contact material composition, contact material thickness, contact force, contact surface geometry, underlying material composition, underlying material thickness, insulator design, contact base material, or contact lubrication requirements.
- B. A significant change is made to the manufacturing process which impacts the product form, fit, or function.
- C. A significant event occurs during production or end use requiring corrective action to be taken relative to the product design or manufacturing process.

NUMBER GS-12-006	TYPE PRODUCT SPECIFICATION		
TITLE Conan™ Micro miniature Connector System		PAGE 12 of 17	REVISION U
		AUTHORIZED BY Bob Gu	DATE 28 Jan 21
		CLASSIFICATION UNRESTRICTED	

TABLE 1 - QUALIFICATION TESTING

TEST/OPERATION	TEST GROUP																	
	1	2	3	3 A	4	5	5 A	6	7	8	9	10	11	11 A	11 B	12	13	13 A
Product Examination	1	1	1	1	1	1	1	1	1	1	1	1	1	1	1	1	1	1
	10	8	12	12	10	11	11	5	4	4	4	7	5	5	4	-	12	12
Sample Preparation	-	2	2	2	2	2	2	2	2	2	2	2	2	2	2	2	2	2
Plating Thkns. and/or Metal Exam.	-	-	-	-	-	-	-	-	-	-	-	-	-	-	-	3	-	-
Porosity	-	-	-	-	-	-	-	-	-	-	-	-	4	4	3	-	-	-
Contact Resistance	-	-	5	5	5	5	5	-	-	-	-	3	-	-	-	-	5	5
	-	-	7	7	8	7	7	-	-	-	-	5	-	-	-	-	9	9
	-	-	9	9	-	9	9	-	-	-	-	-	-	-	-	-	11	11
	-	-	11	11	-	-	-	-	-	-	-	-	-	-	-	-	-	-
Current Rating	-	-	-	-	-	-	-	-	-	3	-	-	-	-	-	-	-	-
Insulation Resistance	2	-	-	-	-	-	-	-	-	-	-	-	-	-	-	-	-	-
	6	-	-	-	-	-	-	-	-	-	-	-	-	-	-	-	-	-
	8	-	-	-	-	-	-	-	-	-	-	-	-	-	-	-	-	-
Dielectric Withstanding Voltage	3	-	-	-	-	-	-	-	-	-	-	-	-	-	-	-	-	-
	9	-	-	-	-	-	-	-	-	-	-	-	-	-	-	-	-	-
Capacitance	4	-	-	-	-	-	-	-	-	-	-	-	-	-	-	-	-	-
Mating Force	-	-	3	3	3	3	3	-	-	-	-	-	-	-	-	-	3	3
	-	-	-	-	-	-	-	-	-	-	-	-	-	-	-	-	7	7
Un-Mating Force	-	-	4	4	4	4	4	-	-	-	-	-	-	-	-	-	4	4
	-	-	-	-	-	-	-	-	-	-	-	-	-	-	-	-	8	8
Contact Retention	-	3	-	-	-	-	-	4	-	-	-	-	-	-	-	-	-	-
	-	5	-	-	-	-	-	-	-	-	-	-	-	-	-	-	-	-
	-	7	-	-	-	-	-	-	-	-	-	-	-	-	-	-	-	-
Normal Force	-	-	-	-	-	-	-	-	-	-	3	6	-	-	-	-	-	-
Board Retention	-	-	-	-	9	10	10	-	-	-	-	-	-	-	-	-	-	-
Humidity	5	4	-	-	-	-	-	-	-	-	-	-	-	-	-	-	-	-
Thermal Shock	7	6	-	-	-	-	-	-	-	-	-	-	-	-	-	-	-	-
Thermal Shock Phase 1	-	-	6	6	-	-	-	-	-	-	-	-	-	-	-	-	-	-
Temp. & Hum. Phase 2	-	-	8	8	-	-	-	-	-	-	-	-	-	-	-	-	-	-
Hi Temp. Life	-	-	-	-	-	-	-	-	-	-	-	4	-	-	-	-	10	10
Mechanical Shock	-	-	-	-	6	-	-	-	-	-	-	-	-	-	-	-	-	-
Vibration	-	-	-	-	7	-	-	-	-	-	-	-	-	-	-	-	-	-
Durability (30 cycles)	-	-	10	-	-	6	-	-	-	-	-	-	3	-	-	-	6	-
Durability (200 Cycles)	-	-	-	10	-	-	6	-	-	-	-	-	-	3	-	-	-	6
Battelle Imfg	-	-	-	-	-	8	8	-	-	-	-	-	-	-	-	-	-	-
Resistance to IR Heat	-	-	-	-	-	-	-	3	-	-	-	-	-	-	-	-	-	-
Solderability	-	-	-	-	-	-	-	-	3	-	-	-	-	-	-	-	-	-

NUMBER GS-12-006	TYPE PRODUCT SPECIFICATION	FCJ	
TITLE Conan™ Micro miniature Connector System		PAGE 13 of 17	REVISION U
		AUTHORIZED BY Bob Gu	DATE 28 Jan 21
		CLASSIFICATION UNRESTRICTED	

FIGURE 1.0

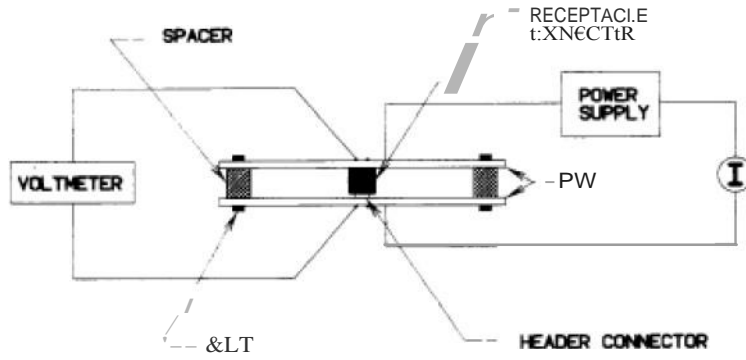

NUMBER GS-12-006	TYPE PRODUCT SPECIFICATION	FCJ	
TITLE Conan™ Micro miniature Connector System		PAGE 14 of 17	REVISION U
		AUTHORIZED BY Bob Gu	DATE 28 Jan 21
		CLASSIFICATION UNRESTRICTED	

FIGURE 2.0

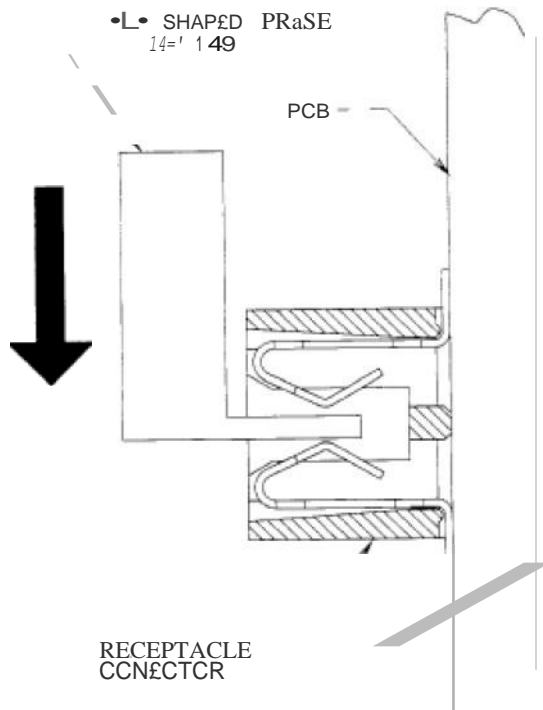

NUMBER GS-12-006	TYPE PRODUCT SPECIFICATION	FCJ	
TITLE Conan _{rM} Micro miniature Connector System		PAGE 15 of 17	REVISION U
		AUTHORIZED BY Bob Gu	DATE 28 Jan 21
		CLASSIFICATION UNRESTRICTED	

FIGURE 3.0

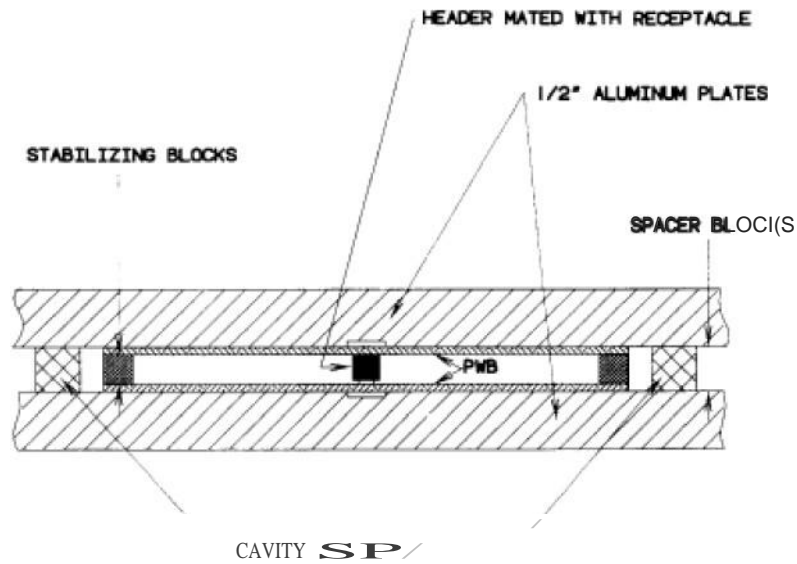

NUMBER GS-12-006	TYPE PRODUCT SPECIFICATION	FCJ	
TITLE Conan _{TM} Micro miniature Connector System		PAGE 16 of 17	REVISION U
		AUTHORIZED BY Bob Gu	DATE 28 Jan 21
		CLASSIFICATION UNRESTRICTED	

POS	Dim "c"	Dim "c"	Dim "E"
9	.157 [4.00]	.118 [J.00]	.1990 [5.055]
11	.197 [5.00]	.157 [4.00]	.2380 [6.045]
15	.275 [7.00]	.215 [6.00]	.3170 [8.052]
21	.54 [10.00]	.118 [J.00]	-.11048]
	.472 [12.00]	-.118 [1.100]	-.5140 [13.058]
31	.91 [1.00]	-.118 [14.00]	.8320 [16.052]
41	.767 [20.00]	.748 [15.00]	.11290 [21.007]
51	.984 [25.00]	.945 [24.00]	1.0280 [26.0110]
1W	1.338 [34.00]	1.289 [33.00]	1.3600 [35.052]

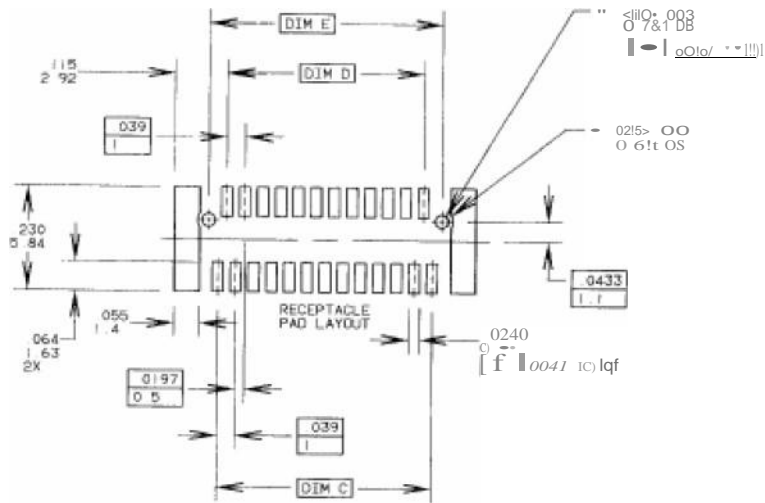

NUMBER GS-12-006	TYPE PRODUCT SPECIFICATION		
TITLE Conan™ Micro miniature Connector System		PAGE 17 of 17	REVISION U
		AUTHORIZED BY Bob Gu	DATE 28 Jan 21
		CLASSIFICATION UNRESTRICTED	

REVISION RECORD

REV	PAGE	DESCRIPTION	EC #	DATE
1	All	Created new product spec.		10/14/91
A	All	Various changes Released	V22342	04/16/92
B	15	Change dim. on drawing .236 to .230 .082 to .064 .098 to .095	V33470	07/09/92
C	All	Rewrite the following sections: Change title 1.0, 4.1, 4.6, 5.2, 5.4, 6.1, 7.2, 7.3, 8.6, 8.8, 9.3, Table 1	V31757	09/29/93
D	All	Correct spelling in header 2.0 - change "family of products" to "system" 9.3 - add Test group 13	V31770	10/07/93
E	2,3,4 5,6,7 8,9 12	Update 4.6, 5.3.2, 6.2, 7.2, 7.3 7.4.5, 8.3 Remove 8.9 Section and renumber Add Test Group 7 and delete 13 Update chart	V40605	01/26/94
F	15 2	Change Connector to Receptacle on dwg. Add 4.6.4	V40450	03/21/94
G	10,12 3 9	Add Test Group #13 Update 5.3.1 and 6.1 Update 8.0	V51216	10/16/95
H	10,12 7	Add 3A, 5A and 13A Sect. 8.3 - Change Phase II to read 'Phase 2'; change Phase III to read '8.3.1'.	V60740	03/18/97
J	4	Para. 6.2 - add 5.5mm and 7.5mm.	V70778	05/08/97
K	All	Revised format to be consistent with GS-01-001, and change BERG, Dupont, etc. references to FCI. Change document number prefix from GES to GS.	V01949	08/15/00
L	1,3	4.0 Add statement for document control precedence. 5.4.2 Add statement concerning allowance for open knit lines.	V03-1033	09/12/03
M	All 1,2,3,9	Change Logo Add Lead-Free information	M06-0295	08/01/06
N	2	MIL-STD-1344 was replaced by EIA-364	M06-0326	08/25/06
P	3	Remove "Tin Lead" information	M07-0357	08/09/07
R	3	Add "Trade Mark" at GXT .	M08-0012	01/11/08
S	2 & 3	Add "Tin Lead" information and new series	M08-0042	02/13/08
T	2 & 3	Change Solderability, Porosity & Adhesion Specifications; remove Obsolete specifications. Add new plating option	M08-0204	07/29/08
U	2 & 4	Add the P/N 10137985 and item 5.5	ELX-N-39798	08/06/21