

HANDLING PROCEDURES AND REMARKS FOR
CONNECTOR USED FOR CIC WITH 1mm CONTACT
SPACING COPING WITH AUTOMATIC MOUNTING AND SMT
S F W ___ S - 6 S T E ___

1. Mounting method of the connector on P.C.Board

This connector applies the construction which copes with automatic mounting and SMT. Therefore please proceed reflow soldering after mounting it on P.C.Board by automatic mounting machine.

Packing style of connector	Plastic tape which cope with JIS C 0806
Automatic mounting machine	One by one system
Soldering	Reflow soldering (V.P.S.Infrared reflow system etc.)

2. BASIC OPERATION PROCEDURES OF CONNECTOR

Conductor connections after soldered the connector on P.C.Board shall be done by the following procedures.

Pulling conductor forcibly in the condition of slider being locked must be avoided.

Works	No.	Operating Procedure
Connecting of conductor	1	Provide open status by pulling slider
	2	Match connecting side of conductor to connecting side of connector
	3	Fix temporarily by inserting conductor parallel into card slot
	4	Provide lock status by pressing slider into
Removing of conductor	5	Provide open status by operating both edges of slider or turning minus driver.
	6	Extract conductor to upper direction against P.C.Board

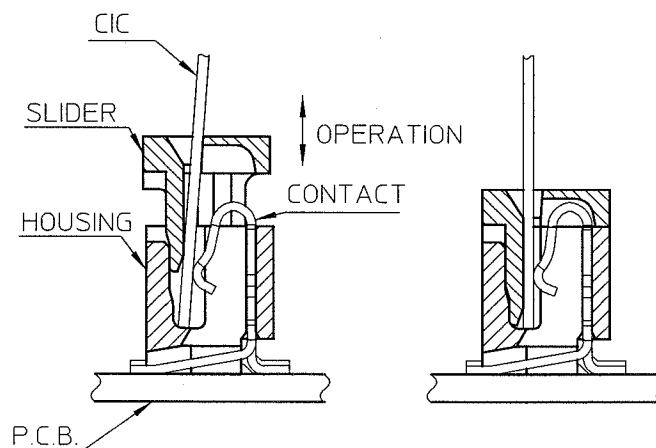

3. Handling procedure details and remarks

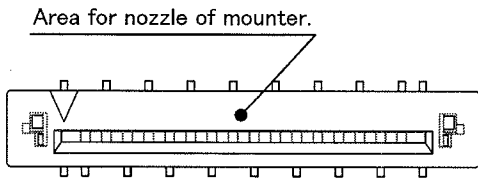
No.	Procedure	Remarks
3-1	<p><u>Cream solder coating</u> Coat cream solder with adequate quantity on P.C.B. pattern. <Recommended cream solder> JIS Z 3282 H60A or H63A Solder particle : More than 200 mesh Flux : Inactive rosin family flux</p>	<ul style="list-style-type: none"> · Please refer to the drawings attached to the specification for recommended P.C.B pattern dimensions. · Please coat cream solder with adequate quantity by adjusting thickness of stencil.
3-2	<p><u>Mounting on P.C.Board</u> By using automatic mounting machine (One by one system) which copes with plastic tape packing. Mount the connector on predetermined position on P.C.Board coated with cream solder.</p> <div style="text-align: center;">  <p style="text-align: center;">Top view</p> </div>	<ul style="list-style-type: none"> · Please confirm carefully mounting accuracy of automatic mounting machine and dimensional accuracy of P.C.B. · Use by selecting adequate one for vacuum nozzle diameter of automatic mounting machine.
3-3	<p><u>Reflow soldering</u> 1) Soldering method Solder by using reflow bath. <Recommended soldering condition> V.P.S. a) Preheat 150°C 60~120 sec. b) Soldering 215°C 10~30 sec. Infrared ray reflow or hot air reflow a) Preheat 150°C 120sec. b) Soldering peak 240°C 215°C 10~30sec.</p> <p><u>Note</u> Temperature shown above Indicates it of contact terminal portion.</p> <p>2) Cleaning Cleaning of flux residue is recommended by considering the reliability of insulation resistance and corrosion characteristics after soldered.</p>	<ul style="list-style-type: none"> · Set temperature on the surface of P.C.B. under 260°C.

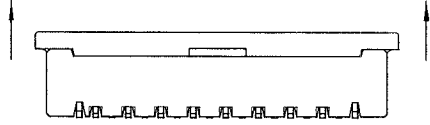
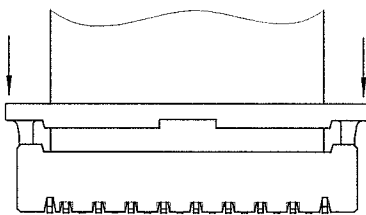
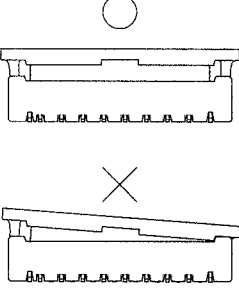
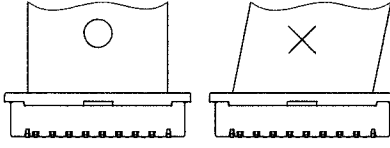
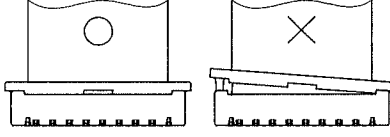
No.	Procedure	Remarks
3-4	<p>Connection of conductor(CIC)</p> <p>1) Provide open status by operating slider. In this case, operate both edges of slider by all means.</p>  <p>2) Conductive side(Finger portion) of conductor is matched to contacting portion of connector.</p> <p>3) Insert conductor from the inserting window of connector parallel until it hits against. (In this condition, connector is fixed temporarily)</p> <p>4) After confirming that the conductor is inserted correctly, lock slider. In this case, confirm that both edges are locked securely by operating both edges of slider.</p> 	<p>· When providing open status by operating slider, operate the both edges parallel until they stop perfectly.</p>  <p>· Make conductor vertically against slider by all means at the condition of being slider locked by inserting conductor.</p>  <p>· At the condition of being slider locked, adjust so as not to have any gap at connecting portion of slider and main body.</p>  <p>· Do not put excess force on conductor and connector at the condition of being conductor mated.</p>

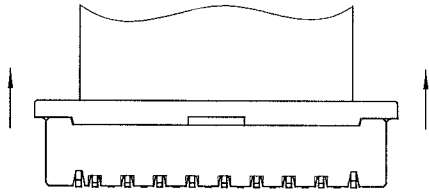
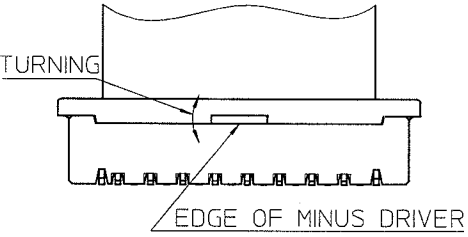
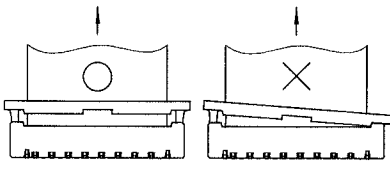
No.	Procedure	Remarks
3-5	<p>Removing of conductor(CIC)</p> <p>1) Provide open status by operating slider. In this case, operate both edges of slider by all means.</p>  <p>Also operate by turning minus driver after putting into the slot for operating fixture.</p>  <p>2) Extract conductor to upper direction against P.C.Board.</p>	<ul style="list-style-type: none"> • Excessive operation may cause break of slider. • Remove conductor after making slider open status perfectly. 

4. OTHER REMARKS

- 4-1) Do not insert lead other than CIC and probe etc. directly into contacting portion.
Since FPC(Flexible Printed Circuit) and FFC(Flexible Flat Cable) can not be used for this product, please consult us separately.
- 4-2) Do not make any soldering in the condition of being conductor mated.
- 4-3) Please use carbon paste CIC.

5. STORAGE OF CONNECTOR

- 5-1) Avoid the places where dust, oil and water etc. are splashed or have direct sunshine.
Solderability may be deteriorated if the connector is stocked for long time under high temperature, high humidity.
- 5-2) Preferable stock condition
- | | |
|-------------|--------------------|
| Temperature | : Less than 30°C |
| Humidity | : Less than 60% RH |
| Period | : Within 3 months |