

This document is the property of Amphenol Corporation and is delivered on the express condition that it is not to be disclosed, reproduced or used, in whole or in part, for manufacture or sale by anyone other than Amphenol Corporation without its prior consent, & that no right is granted to disclose or to use any information in this document.

# CUSTOMER DRAWING

## REVISIONS

SYM	ECN	DESCRIPTION	DATE	APPROVED
1	CDXXXX	PRELIMINARY PROPOSAL	May.30,2018	YH
2	CDXXXX	REVISE THE PCB GOLD FINGER	Jul.18,2018	YH
3	CDXXXX	REVISE THE PCB THICKNESS TOLERANCE AND SLOT	Aug.17,2018	YH
4	CD1555	UPDATED BY SFF TA 1002 REV 1.1.3	Nov.08,2018	YH
5	CD1817	CHANGE NUT FROM STANDARD TO RECTANGLE AND ADD PACKING	Jul.11,2019	YH
6	CD1856	STANDARDIZE THE WAFER CONSTRUCTURE	Sep.24,2019	YH

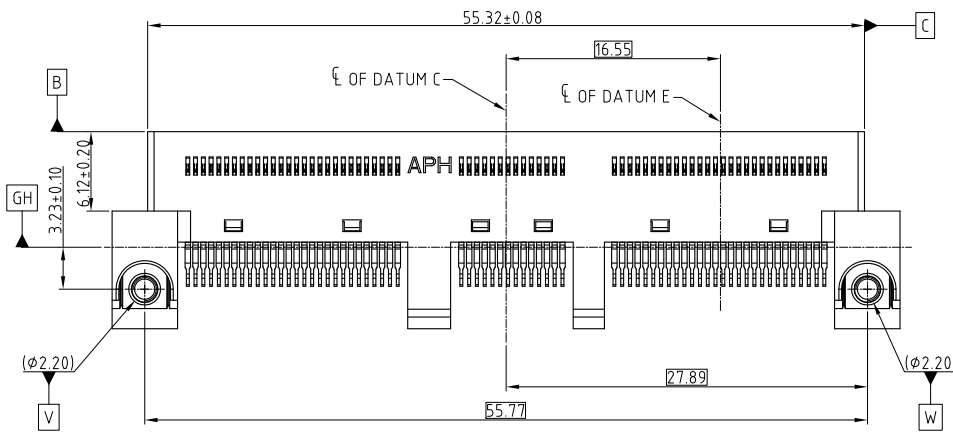
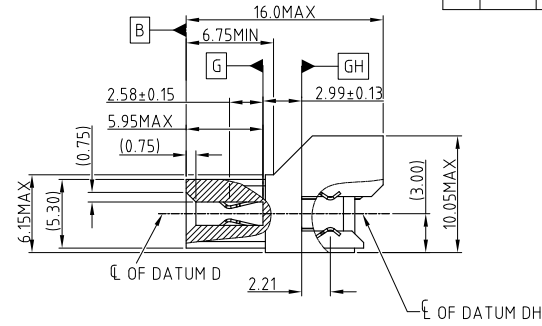
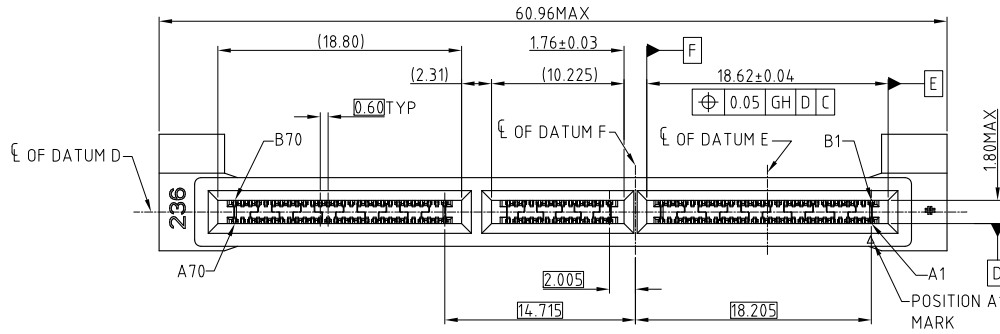

**NOTE:**

- MATERIAL:**  
HOUSING: HIGH TEMPERATURE THERMOPLASTIC BLACK UL94-V0  
CONTACT: COPPER ALLOY  
NUT: STAINLESS STEEL
- PLATING:**  
CONTACT: MATING AREA: Au THICKNESS PLEASE REFER TO P/N SYSTEM  
OVER 1.27-2.54 μm NICKEL UNDERPLATED  
SOLDER AREA: 1.27 μm MIN TIN OVER 1.27-2.54 μm NICKEL UNDERPLATED
- ELECTRICAL PERFORMANCE:**  
RATED CURRENT: 1.1A/PIN UP TO 12PINS  
LLCR: 30mΩ MAX, DELTA 15 mΩ  
INSULATION RESISTANCE: 1000MΩ MIN
- DURABILITY: 200 CYCLES.**
- MATERIAL SHOULD BE FULFILLED AMPHENOL SPEC# S-SN-002 AND S-SN-004**
- ORDERING PN SYSTEM : ME101401340120X**

- PLATING SPEC
- 0.76um Au
  - 0.38um Au
  - GOLD FLASH
  - PdNi 0.76um+G/F

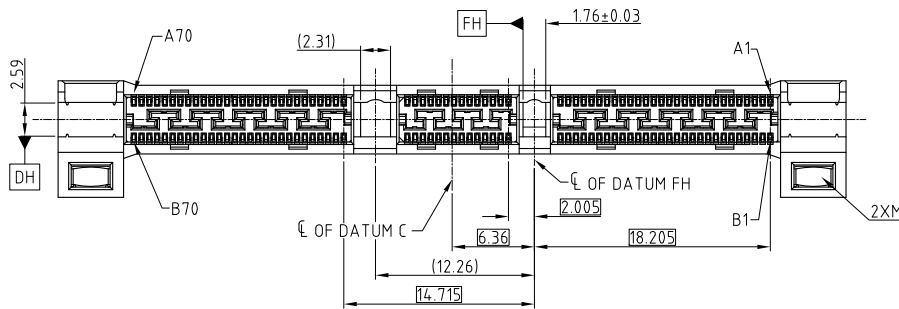

UNLESS OTHERWISE SPECIFIED TOLERANCES		APPROVAL	DATE
	U.S.	DRAWN	Teng.Cao Sep.24,2019
	METRIC	CHECKED	Ly.Yi Sep.24,2019
X	+/-	APPROVED	
.XX	+/-		
.XXX	+/-		
FRACTIONS	+/-		
ANGLES	+/-		
		DRAWING FILE :	
FOR MATERIALS AND FINISHES SEE NOTES		INTERNAL\ME\C	ME101401340120X
REMOVE SHARP EDGES		ANGLE OF PROJECTION	
DIMENSIONS			
U.S.	INCHES		
(METRIC)	(mm)		

<b>Amphenol</b>			
TITLE			
MINI COOL EDGE CONNECTOR			
140P S/M MATE 2.36 HOST PCB			
SIZE	DRAWING NO.	REV.	
A3	C ME101401340120X	6	
SCALE	NONE	SHEET 1 OF 3	

This document is the property of Amphenol Corporation and is delivered on the express condition that it is not to be disclosed, reproduced or used, in whole or in part, for manufacture or sale by anyone other than Amphenol Corporation without its prior consent, & that no right is granted to disclose or to use any information in this document.

# CUSTOMER DRAWING

REVISIONS				
SYM	ECN	DESCRIPTION	DATE	APPROVED
		SEE SHEET 1		

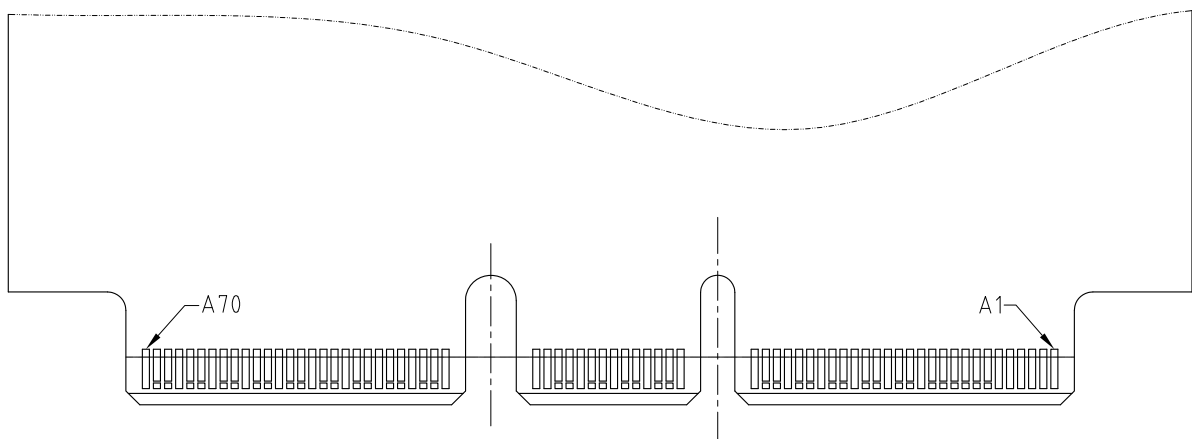
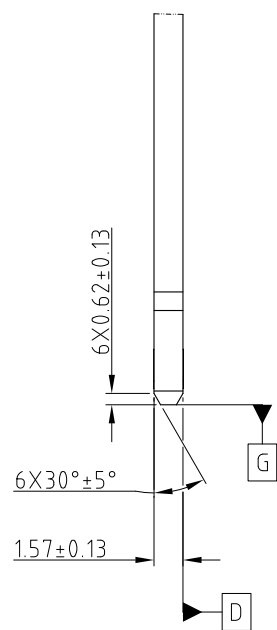
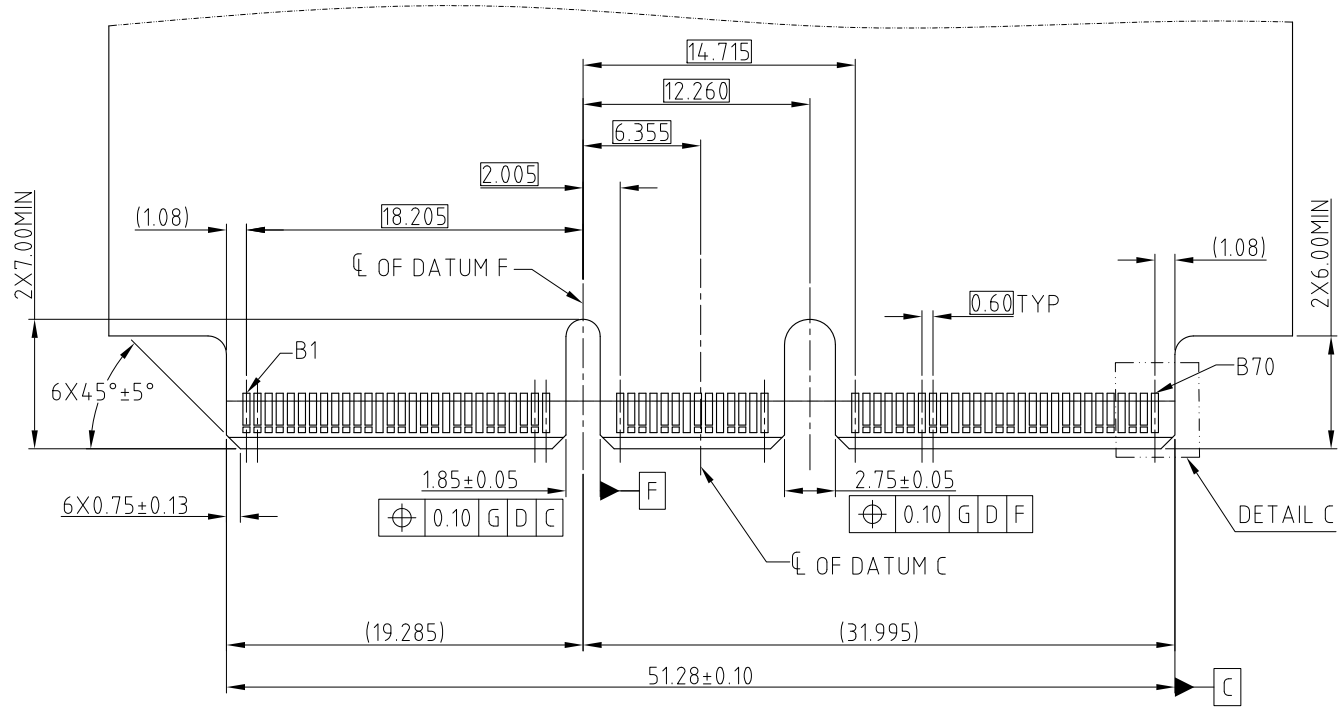

RECOMMENDED AIC MATING CARD

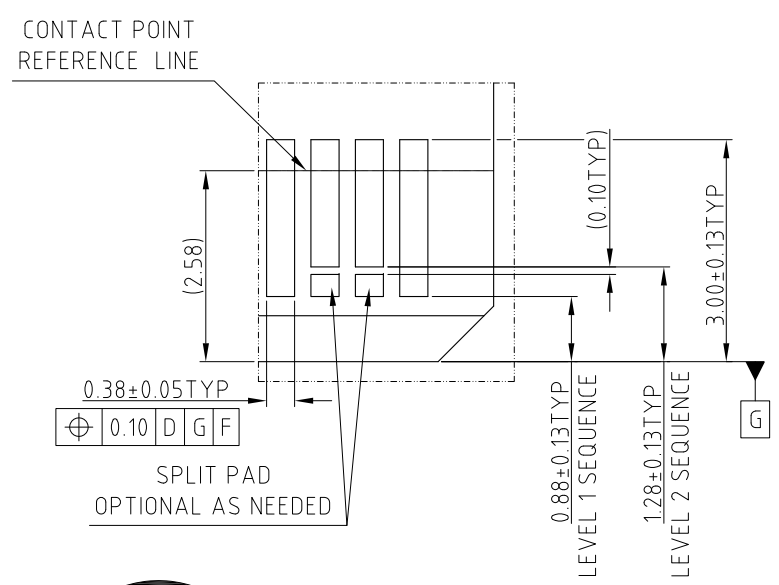

DETAIL C  
SCALE 4:1

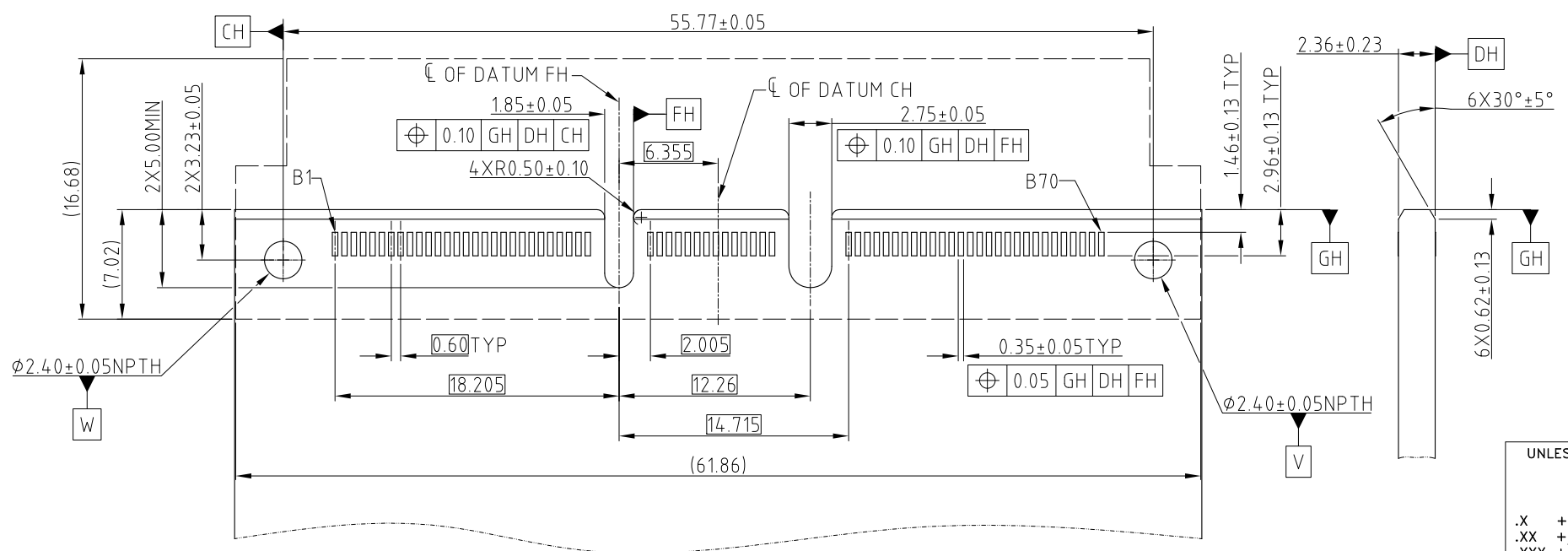

NOTE: POSITION A1 ON THE OPPOSITE SIDE OF CARD OF B1  
RECOMMENDED FOOTPRINT

UNLESS OTHERWISE SPECIFIED TOLERANCES	
U.S.	METRIC
.X +/-	0.25
.XX +/-	0.20
.XXX +/-	0.15
FRACTIONS +/-	5°
ANGLES +/-	

APPROVAL	DATE
DRAWN Teng.Cao	Sep.24,2019
CHECKED Ly.Yi	Sep.24,2019
APPROVED	

Amphenol		
TITLE MINI COOL EDGE CONNECTOR 140P S/M MATE 2.36 HOST PCB		
SIZE A3	DRAWING NO. C ME101401340120X	REV. 6
SCALE NONE	SHEET 2 OF 3	

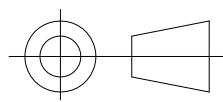

This document is the property of Amphenol Corporation and is delivered on the express condition that it is not to be disclosed, reproduced or used, in whole or in part, for manufacture or sale by anyone other than Amphenol Corporation without its prior consent, & that no right is granted to disclose or to use any information in this document.

CUSTOMER DRAWING

REVISIONS				
SYM	ECN	DESCRIPTION	DATE	APPROVED
		SEE SHEET 1		

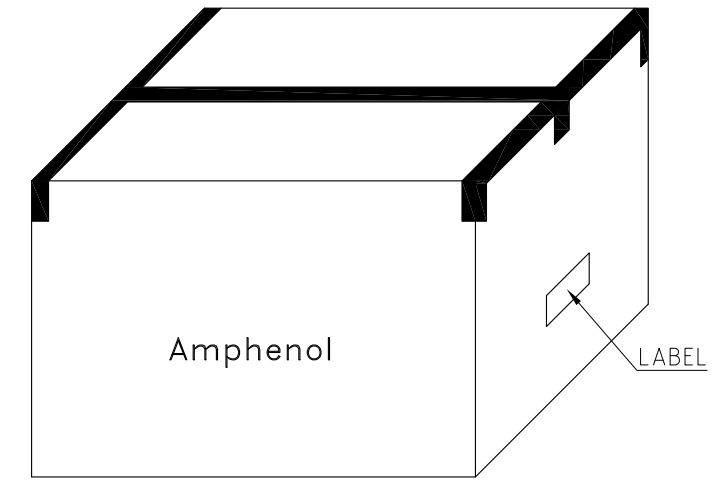
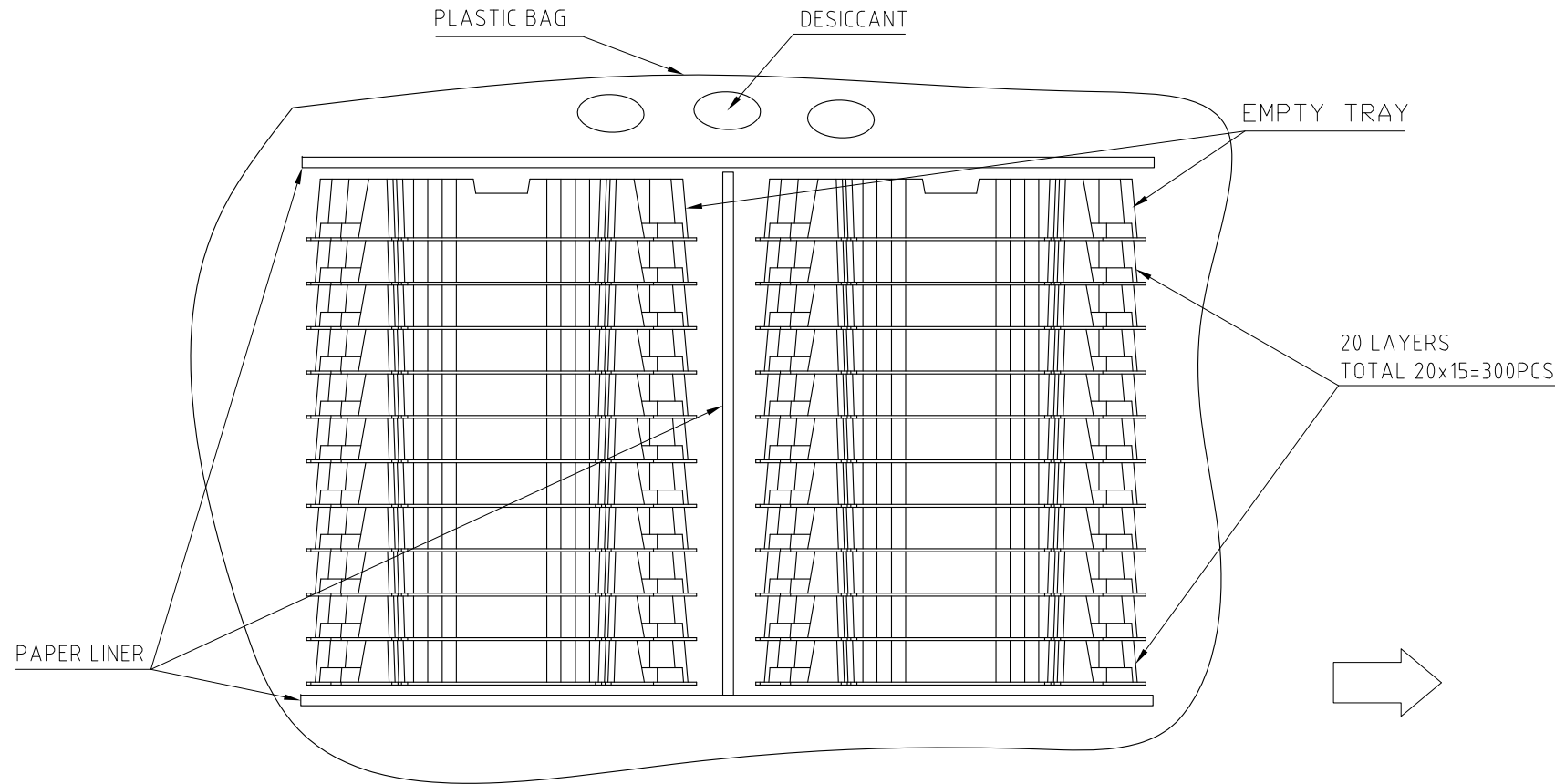

300PCS / CARTON

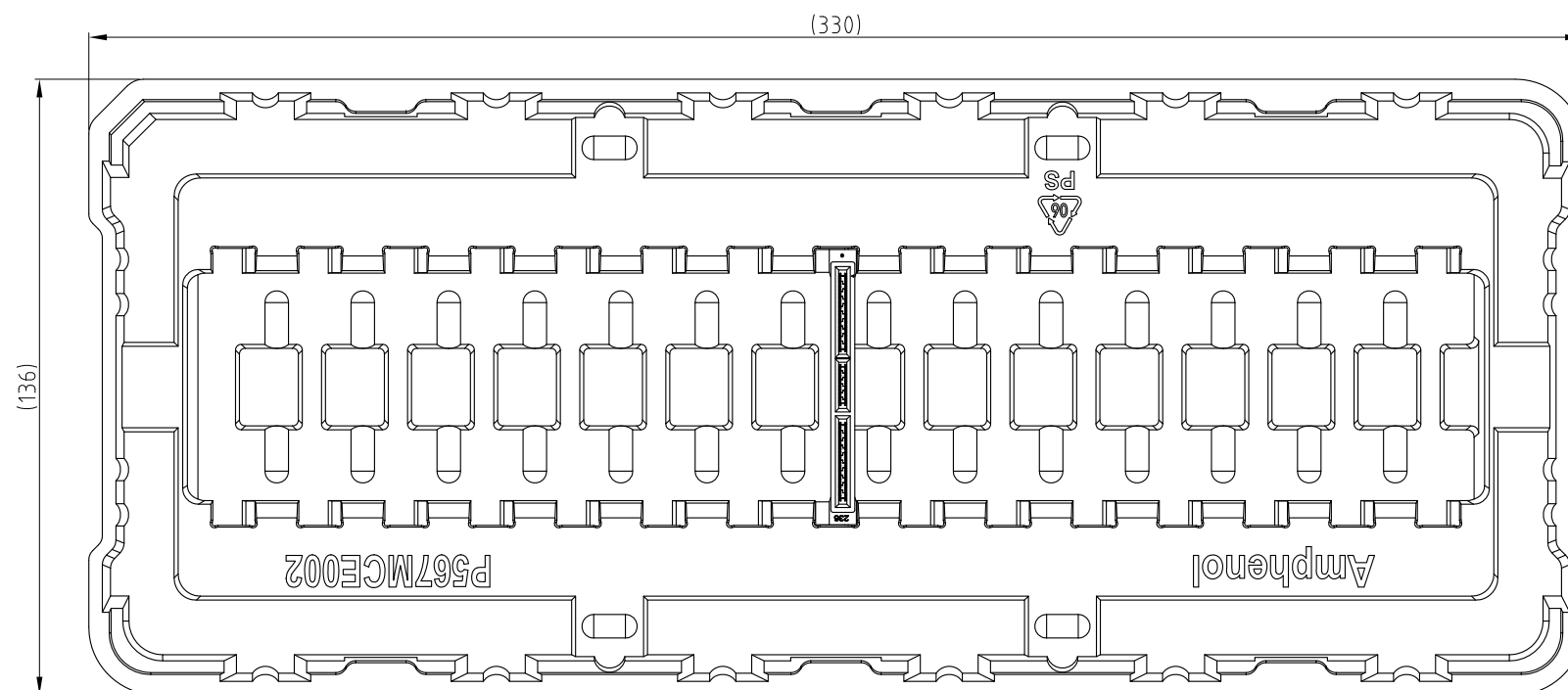
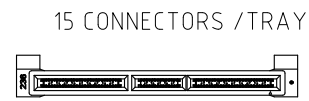

UNLESS OTHERWISE SPECIFIED TOLERANCES		APPROVAL	DATE	Amphenol		
	U.S. METRIC	DRAWN	Teng.Cao			Sep.24,2019
.X +/-	0.25	CHECKED	Ly.Yi			Sep.24,2019
.XX +/-	0.20	APPROVED				
.XXX +/-	0.15	DRAWING FILE :		TITLE		
FRACTIONS +/-	5°	INTERNAL\ME\C ME101401340120X		MINI COOL EDGE CONNECTOR		
ANGLES +/-		ANGLE OF PROJECTION		140P S/M MATE 2.36 HOST PCB		
FOR MATERIALS AND FINISHES SEE NOTES		REMOVE SHARP EDGES		SIZE	DRAWING NO.	
DIMENSIONS				A3	C ME101401340120X	
—U.S.—	INCHES			REV.	6	
(METRIC)	(mm)			SCALE	NONE	
				SHEET 3 OF 3		